



4-Channel Video Reconstruction Filter

MAX7445

General Description

The MAX7445 4-channel, buffered video reconstruction filter is ideal for anti-aliasing and DAC-smoothing video applications or wherever analog video is reconstructed from a digital data stream (such as cable/satellite/terrestrial set-top boxes, DVD players, hard-disk recorders (HDRs), and personal video recorders (PVRs)). This device operates from a single +5V supply and has a flat passband out to 5MHz with a stopband attenuation of 43dB at 27MHz. This makes it ideal for use with NTSC, PAL, and standard-definition digital TV (SDTV) video systems. Each output is capable of driving two standard 150Ω video loads.

The MAX7445 has three modes of operation. Mode 1 processes CVBS and RGB video signals. Mode 2 processes CVBS, Y, and C signals, as well as a second asynchronous CVBS video signal. Mode 3 processes RGB and CVBS (asynchronous) video signals. An external pin adjusts the gain of the video buffer to either +6dB, +9.5dB, or +12dB to accommodate video-encoder DAC output signals of <1V. High-frequency boost circuitry provides picture sharpness with +1.2dB of gain boost without degradation in the stopband. The output video drivers can be disabled with an external pin.

The MAX7445 is available in a 14-pin TSSOP package with an exposed pad, and is specified over the -40°C to +85°C extended temperature range.

Applications

- | | |
|-----------------------|--------------|
| Set-Top Boxes/HDRs | DVD Players |
| Game Consoles | Digital VCRs |
| Desktop Video Editors | |

Features

- ◆ 4-Channel Filter and Buffer for CVBS, RGB, or Y/C Video Signals
- ◆ Filter Response Ideal for NTSC, PAL, and Interlaced SDTV Video Signals
- ◆ 43dB (typ) Stopband Attenuation at 27MHz
- ◆ ±0.75dB (max) Passband Ripple Out to 5MHz
- ◆ Blanking Level Voltage on Cable <1V
- ◆ Each Channel Drives Two 150Ω Video Loads
- ◆ +5V Single-Supply Voltage
- ◆ Selectable Gain: +6dB, +9.5dB, and +12dB
- ◆ Small 14-Pin TSSOP Package

Ordering Information

PART	TEMP RANGE	PIN-PACKAGE
MAX7445EUD	-40°C to +85°C	14 TSSOP-EP*

*EP = Exposed pad.

Pin Configuration appears at end of data sheet.

Functional Diagram

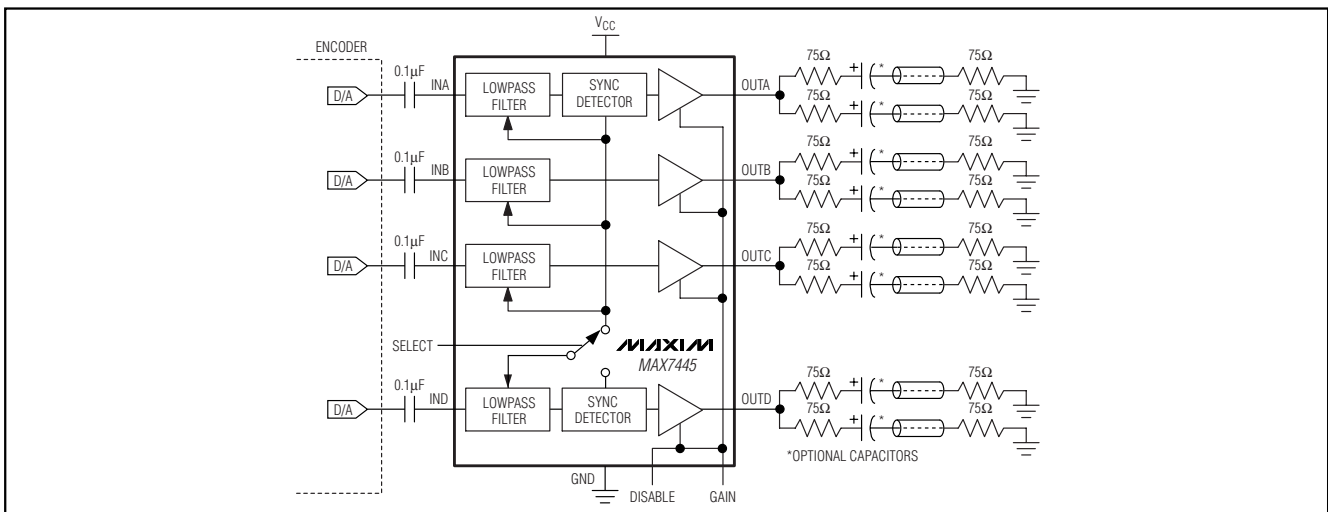

4-Channel Video Reconstruction Filter

ABSOLUTE MAXIMUM RATINGS

V_{CC} to GND+6V
 All Other Pins to GND.....-0.3V to (V_{CC} + 0.3V)
 Maximum Current into Any Pin Except V_{CC} and GND±50mA
 Continuous Power Dissipation (T_A = +70°C)
 TSSOP-EP (derate 20.8mW/°C above +70°C).....1667mW

Operating Temperature Range-40°C to +85°C
 Storage Temperature Range-65°C to +150°C
 Junction Temperature+150°C
 Lead Temperature (soldering, 10s)+300°C

Stresses beyond those listed under "Absolute Maximum Ratings" may cause permanent damage to the device. These are stress ratings only, and functional operation of the device at these or any other conditions beyond those indicated in the operational sections of the specifications is not implied. Exposure to absolute maximum rating conditions for extended periods may affect device reliability.

ELECTRICAL CHARACTERISTICS

(V_{CC} = +5V ±5%, C_L = 0 to 20pF, R_L = 75Ω to GND for DC-coupled load, R_L = 75Ω to V_{CC} / 2 for AC-coupled load, C_{INL} = 0.1μF, GAIN = GND (+6dB) or V_{CC} (+9.5dB), T_A = T_{MIN} to T_{MAX}, unless otherwise noted. Typical values are at V_{CC} = +5V, T_A = +25°C.)

PARAMETER	SYMBOL	CONDITIONS		MIN	TYP	MAX	UNITS
Passband Response		f = 100kHz to 5MHz, relative to 100kHz	Channel without boost (see Table 2)	-0.75	+0.15	+0.75	dB
			Channel with boost (see Table 2)	+0.9	+1.2	+1.5	
Stopband Attenuation	A _{SB}	f ≥ 27MHz		39	43		dB
Differential Gain	dG	5-step modulated staircase	Gain = +6dB, +9.5dB		0.15	0.50	%
			Gain = +12dB		0.25	0.90	
Differential Phase	dθ	5-step modulated staircase	Gain = +6dB, +9.5dB		0.15	0.50	Degrees
			Gain = +12dB		0.15	0.60	
Signal-to-Noise Ratio	SNR	Peak signal (2V _{p-p}) to RMS noise, f = 100Hz to 50MHz	Gain = +6dB, +9.5dB, +12dB	69	75		dB
Group Delay Deviation	Δt _g	Deviation from 100kHz to 4.1MHz	Channel without boost (see Table 2)		11	20	ns
			Channel with boost (see Table 2)		17	30	
Line-Time Distortion	H _{DIST}	18μs, 100 IRE bar				0.3	%
Field-Time Distortion	V _{DIST}	130 lines, 18μs, 100 IRE bar				0.5	%
Clamp Settling Time	t _{CLAMP}	To ±1%				100	Lines
Output DC Clamp Level		SELECT = GND	Channel A	0.6	0.9	1.1	V
			Channels B, C, D	1.1	1.5	1.8	
		SELECT = V _{CC}	Channels A, B, D	0.6	0.9	1.1	
			Channel C	1.25	1.6	1.95	
		SELECT = floating	Channels A, D	0.6	0.9	1.1	
Channels B, C	1.1	1.5	1.8				
Low-Frequency Gain Accuracy	A _v	f = 100kHz, relative to a gain of +6dB		-3		+3	%
Low-Frequency Gain Matching	A _{v(MATCH)}	Low-frequency channel-to-channel matching, f = 100kHz				4	%

4-Channel Video Reconstruction Filter

MAX7445

ELECTRICAL CHARACTERISTICS (continued)

($V_{CC} = +5V \pm 5\%$, $C_L = 0$ to $20pF$, $R_L = 75\Omega$ to GND for DC-coupled load, $R_L = 75\Omega$ to $V_{CC} / 2$ for AC-coupled load, $C_{IN_} = 0.1\mu F$, GAIN = GND (+6dB) or V_{CC} (+9.5dB), $T_A = T_{MIN}$ to T_{MAX} , unless otherwise noted. Typical values are at $V_{CC} = +5V$, $T_A = +25^\circ C$.)

PARAMETER	SYMBOL	CONDITIONS		MIN	TYP	MAX	UNITS
Group Delay Matching	$t_{g(MATCH)}$	Low-frequency channel-to-channel matching, $f = 100kHz$			2		ns
Channel-to-Channel Crosstalk	X_{TALK}	$f = 100kHz$ to $3.58MHz$			60		dB
Output Short-Circuit Current	I_{SC}	OUT_ shorted to GND or V_{CC}			70		mA
Input Leakage Current	I_{IN}					10	μA
Input Dynamic Swing for Gain of +6dB		SELECT = GND	Channel A			1.2	V _{P-P}
			Channels B, C, D			0.9	
		SELECT = V_{CC}	Channels A, B, D			1.2	
			Channel C			0.9	
		SELECT = floating	Channels A, D			1.2	
			Channels B, C			0.9	
SUPPLY							
Supply Voltage Range	V_{CC}			4.75		5.25	V
Supply Current	I_{CC}	No load			100	140	mA
Power-Supply Rejection Ratio	PSRR	$V_{IN} = 100mV_{P-P}$, $f = 0$ to $3.5MHz$			40		dB
DISABLE							
Output Impedance During Disable	$Z_{DISABLE}$	At $5MHz$			2		k Ω
Disable Logic-Input High Voltage	V_{IH}			2.0			V
Disable Logic-Input Low Voltage	V_{IL}					0.8	V
Disable Logic Input Current	$I_{DISABLE}$	$V_{IL} = 0V$ (sink), $V_{IH} = V_{CC}$ (source)				± 10	μA

4-Channel Video Reconstruction Filter

Typical Operating Characteristics

($V_{CC} = +5V$, $V_{GAIN} = 0V$, $T_A = +25^\circ C$, unless otherwise noted.)

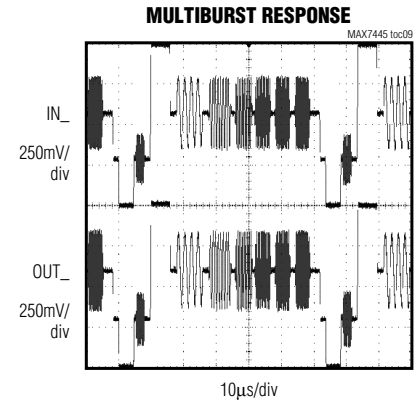
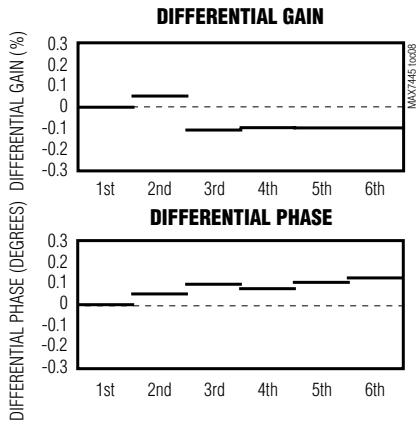
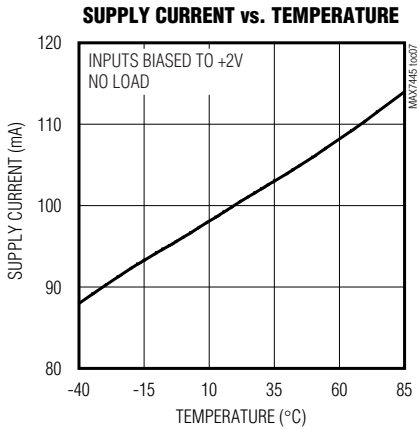
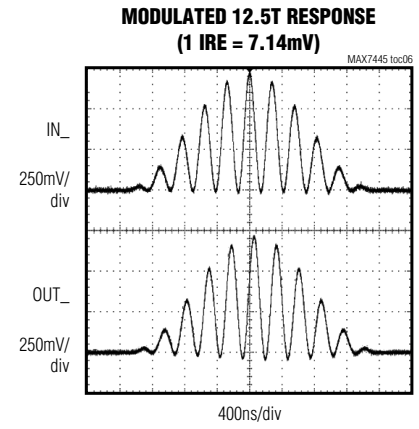
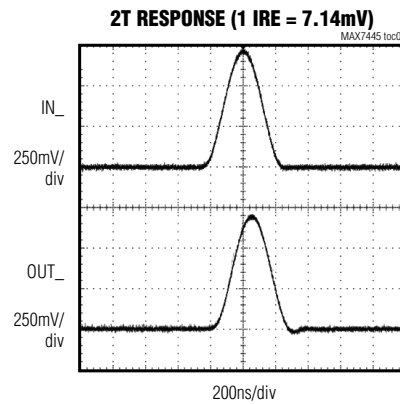
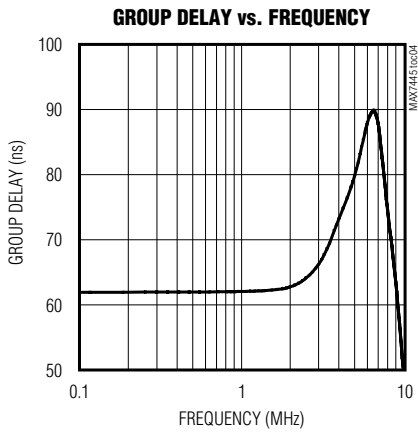
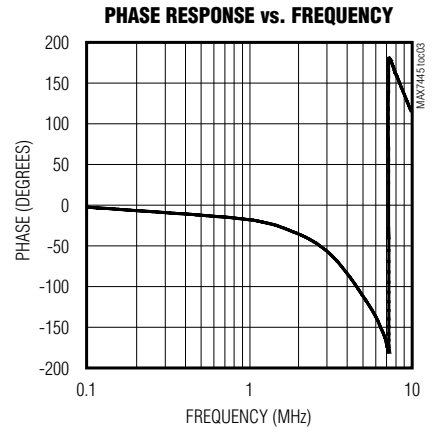
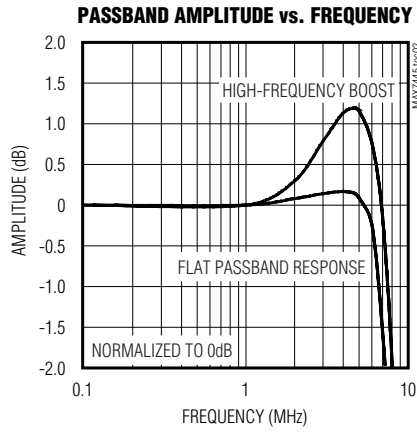
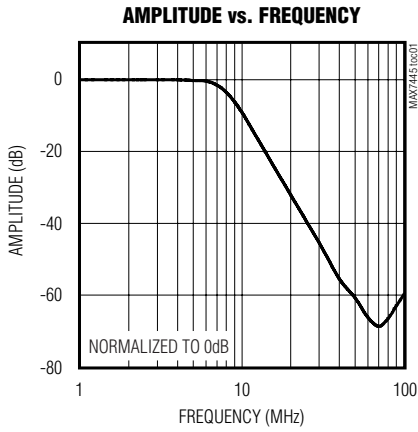

4-Channel Video Reconstruction Filter

MAX7445

Pin Description

PIN	NAME	FUNCTION
1	INA	Channel A Video Input. AC-couple INA with a series 0.1 μ F capacitor.
2	INB	Channel B Video Input. AC-couple INB with a series 0.1 μ F capacitor.
3	INC	Channel C Video Input. AC-couple INC with a series 0.1 μ F capacitor.
4	IND	Channel D Video Input. AC-couple IND with a series 0.1 μ F capacitor.
5	DISABLE	Disable Logic Input. A logic-low on DISABLE enables the output buffers. A logic-high on DISABLE disables all output buffers and puts them in a high-impedance state.
6, 8	GND	Ground
7	GAIN	Gain-Control Input. Connect GAIN to GND for a gain of +6dB (+2V/V), to V _{CC} for a gain of +9.5dB (+3V/V), or leave unconnected for a gain of +12dB (+4V/V).
9	SELECT	Mode Select Input. Connect to GND for CVBS/RGB processing, to V _{CC} for CVBS/Y/C/CVBS _{ASYNC} processing, or leave floating for RGB/CVBS _{ASYNC} (G with sync) processing.
10	V _{CC}	+5V Supply Input
11	OUTD	Channel D Video Output. This output can be either AC- or DC-coupled.
12	OUTC	Channel C Video Output. This output can be either AC- or DC-coupled.
13	OUTB	Channel B Video Output. This output can be either AC- or DC-coupled.
14	OUTA	Channel A Video Output. This output can be either AC- or DC-coupled.

Detailed Description

The MAX7445 filters and buffers video-encoder DAC outputs in applications such as set-top boxes, hard-disk recorders, DVD players, and digital VCRs. The MAX7445 reconstructs and cleans up analog video signals from the output of DAC video encoders. Each channel consists of a lowpass filter and an output video buffer that can drive two standard 150 Ω video loads. This device operates from a single +5V supply and has a nominal cutoff frequency of 5MHz optimized for NTSC, PAL, and SDTV.

The MAX7445 has three modes of operation allowing different video signals to be processed. The modes are shown in Table 1. Mode 1 requires that channel A is a video signal that includes a sync pulse. A sync separator uses this signal to extract the timing required to clamp all four channels.

Modes 2 and 3 require that channel A and channel D have a sync pulse to provide the required timing information. Channel A provides the required timing for channels A, B, and C while channel D provides its own sync separator to extract the sync signal from an asynchronous video signal.

Table 1. Operating Modes

MODE	SELECT	CHANNEL	SIGNAL
MODE 1 CVBS/RGB	GND	A	CVBS
		B	R
		C	G
		D	B
MODE 2 CVBS/Y/C/ CVBS _{ASYNC}	V _{CC}	A	CVBS
		B	Y
		C	C
		D	CVBS _{ASYNC}
MODE 3 RGB/CVBS _{ASYNC} (G with sync)	FLOATING	A	G (with sync)
		B	R
		C	B
		D	CVBS _{ASYNC}

Filter

Filter Response

The reconstruction filter consists of two 2nd-order Sallen-Key stages. The Butterworth-type response features a maximally flat passband for NTSC and PAL bandwidths. The stopband offers at least 43dB (typ) of attenuation at a video-encoder DAC sampling frequency of 27MHz (see the *Typical Operating Characteristics*).

4-Channel Video Reconstruction Filter

Table 2. High-Frequency Boost for Each Mode

CHANNEL	HIGH-FREQUENCY BOOST (dB)		
	MODE 1	MODE 2	MODE 3
A	+1.2	+1.2	–
B	–	+1.2	–
C	–	+1.2	–
D	–	+1.2	+1.2

Table 3. Gain Setting Control

GAIN	BUFFER GAIN (dB)
GND	+6
V _{CC}	+9.5
Floating	+12

High-Frequency Boost

The high-frequency boost available on the CVBS, Y, and C video channels increases image sharpness by compensating for signal degradation and roll-off in the video encoder. Table 2 shows the channels that have the high-frequency boost option for the three operating modes. The channels without high-frequency boost have a flat response over the video bandwidth.

Output Buffers

Each output buffer can drive two 150Ω video loads with a 2V_{P-P} signal. The output buffer gain is selectable between +6dB, +9.5dB, or +12dB by using GAIN (see Table 3). The MAX7445 can drive an AC load or drive the video load directly without using a large output capacitor. The output buffers drive DC loads with an output blanking level of less than 1V.

Table 4. Output Clamp Level

CHANNEL	MODE 1: SELECT = GND		MODE 2: SELECT = V _{CC}		MODE 3: SELECT = FLOATING	
	CLAMP LEVEL (V)	SYNC SOURCE	CLAMP LEVEL (V)	SYNC SOURCE	CLAMP LEVEL (V)	SYNC SOURCE
A	0.8	Channel A	0.8	Channel A	0.8	Channel A
B	1.4	Channel A	0.8	Channel A	1.4	Channel A
C	1.4	Channel A	1.6	Channel A	1.4	Channel A
D	1.4	Channel A	0.8	Channel D	0.8	Channel D

12dB Gain Setting

GAIN is biased internally to V_{CC} / 2 with a resistor-divider pair of 100kΩ resistors from V_{CC} to GND such that the internal impedance at the node is 50kΩ. No additional connection is necessary since the input offers a minimum noise-margin immunity of 1V_{P-P}.

Output Clamp Level

When sync pulses are detected in either a CVBS or G video signal, the DC restore loop is activated. The function of the loop is to set the DC level of the video signal to a specified voltage. See Table 4 for clamp levels.

Applications Information

Input Considerations

Use 0.1μF ceramic capacitors to AC-couple the inputs. These input capacitors store a DC level so the outputs are clamped to an appropriate DC voltage level.

Output Considerations

The outputs are typically connected to a 75Ω series back-match resistor followed by the video cable. Because of the inherent divide-by-two of this configuration, the voltage on the video cable is always less than 1V, complying with industry-standard video requirements such as the European SCART standard (which allows up to 2V of DC on the video cable). The video buffer can also drive an AC-coupled video load. Good video performance is achieved with an output capacitor as low as 220μF.

Power-Supply Bypassing and Layout

The MAX7445 operates from a single +5V supply. Bypass V_{CC} to GND with a 0.1μF capacitor. Place all external components as close to the device as possible.

4-Channel Video Reconstruction Filter

Pin Configuration

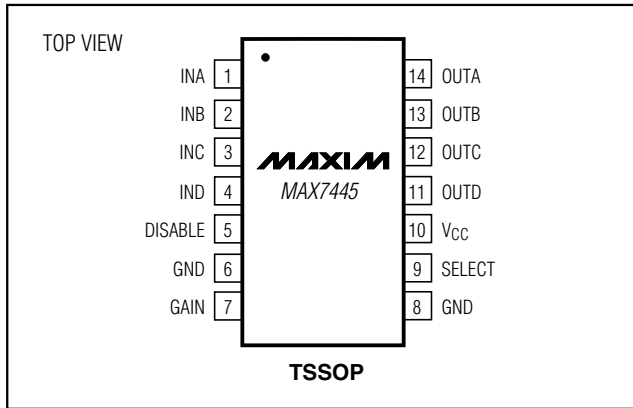

Exposed Pads

The TSSOP-EP package has an exposed pad on the bottom of the package. This pad is electrically connected to GND and should be connected to the ground plane for improved thermal conductivity. Do not route signals under this package.

Chip Information

TRANSISTOR COUNT: 6300

PROCESS: BiCMOS

MAX7445

4-Channel Video Reconstruction Filter

Package Information

(The package drawing(s) in this data sheet may not reflect the most current specifications. For the latest package outline information, go to www.maxim-ic.com/packages.)

TSSOP 4.4mm BODY.EPS

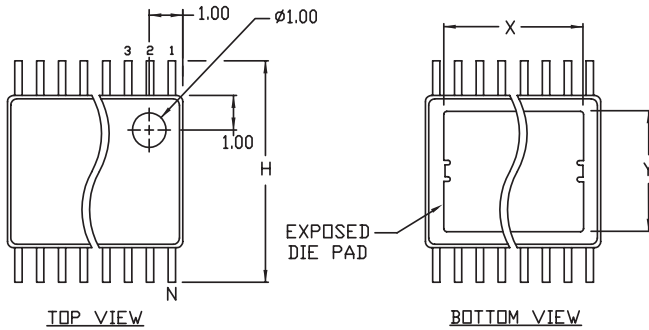

	COMMON DIMENSIONS			
	MILLIMETERS		INCHES	
	MIN.	MAX.	MIN.	MAX.
A	—	1.10	—	.043
A ₁	0.05	0.15	.002	.006
A ₂	0.85	0.95	.033	.037
b	0.19	0.30	.007	.012
b ₁	0.19	0.25	.007	.010
c	0.090	0.20	.0035	.008
c ₁	0.090	0.135	.0035	.0053
D	SEE VARIATIONS		SEE VARIATIONS	
E	4.30	4.50	.169	.177
e	0.65 BSC		.026 BSC	
H	6.25	6.50	.246	.256
L	0.50	0.70	.020	.028
N	SEE VARIATIONS		SEE VARIATIONS	
Y	2.85	3.15	.112	.124
α	0°	8°	0°	8°

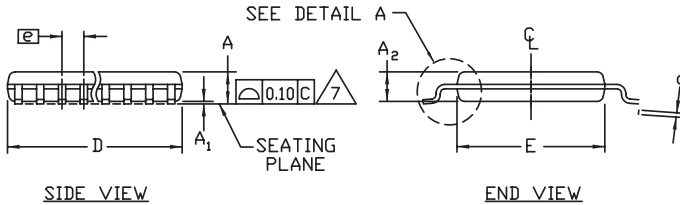

JEDEC	N	VARIATIONS				
		MILLIMETERS		INCHES		
		MIN.	MAX.	MIN.	MAX.	
ABT	16	D	4.90	5.10	.193	.201
		X	2.85	3.15	.112	.124
ACT	20	D	6.40	6.60	.252	.260
		X	4.00	4.34	.157	.171
AET	28	D	9.60	9.80	.378	.386
		X	5.35	5.65	.211	.222

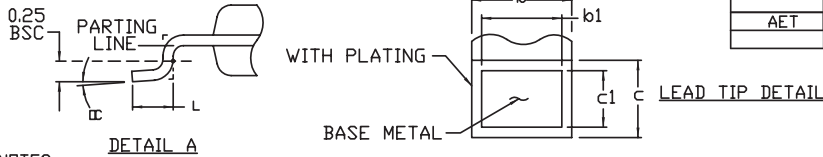

NOTES:

1. DIMENSIONS D AND E DO NOT INCLUDE FLASH
 2. MOLD FLASH OR PROTRUSIONS NOT TO EXCEED 0.15mm PER SIDE
 3. CONTROLLING DIMENSION: MILLIMETER
 4. MEETS JEDEC OUTLINE MO-153. SEE JEDEC VARIATIONS TABLE.
 5. "N" REFERS TO NUMBER OF LEADS
 6. EXPOSED PAD FLUSH WITH BOTTOM OF PACKAGE WITHIN .002"
- △ THE LEAD TIPS MUST LIE WITHIN A SPECIFIED ZONE. THIS TOLERANCE ZONE IS DEFINED BY TWO PARALLEL PLANES. ONE PLANE IS THE SEATING PLANE, DATUM [-C-]; THE OTHER PLANE IS AT THE SPECIFIED DISTANCE FROM [-C-] IN THE DIRECTION INDICATED.

MAXIM

PROPRIETARY INFORMATION

TITLE:
PACKAGE OUTLINE, TSSOP, 4.40 MM BODY, EXPOSED PAD

APPROVAL	DOCUMENT CONTROL NO. 21-0108	REV B	1/1
----------	---------------------------------	----------	-----

Maxim cannot assume responsibility for use of any circuitry other than circuitry entirely embodied in a Maxim product. No circuit patent licenses are implied. Maxim reserves the right to change the circuitry and specifications without notice at any time.

8 Maxim Integrated Products, 120 San Gabriel Drive, Sunnyvale, CA 94086 408-737-7600